

PFB 120 x 120 x 38 MM SERIES

DIMENSIONS DRAWING

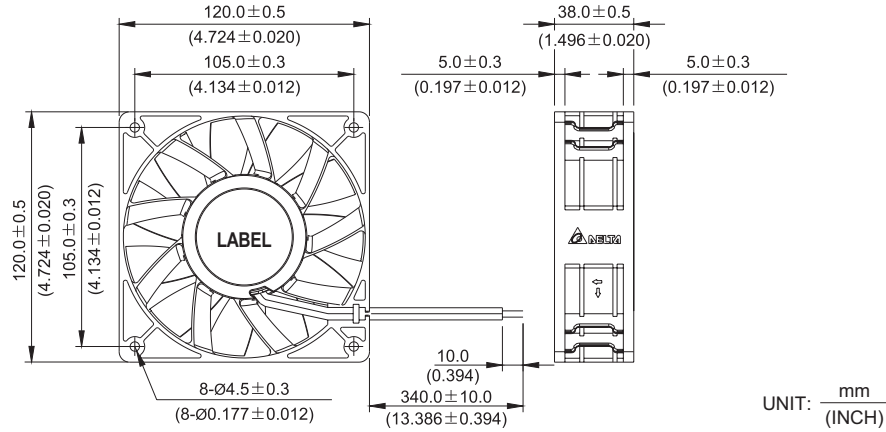

- * Bearing Type
Ball Bearings
- * Material
Impeller & Frame : Plastic (UL 94V-0)
- * Lead Wires :
UL 1007 AWG #24 OR Equivalent
Red Wire Positive (+)
Black Wire Negative (-)
- * Weight : 380g (13.40 oz)

P & Q CURVE (AT RATED VOLTAGE)

MOUNTING PANEL CUTOUT

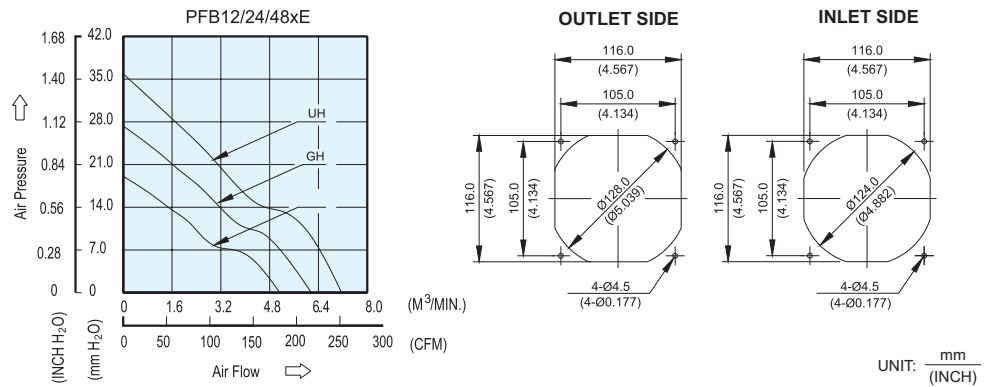

MODEL		Rated Voltage	Operating Voltage Range	Input Current	Input Power	Speed	Maximum Air Flow		Maximum Air Pressure		Noise
PART NO.	FUNCTION	VDC	VDC	Amp	Watt	R.P.M.	m ³ / min	CFM	mmH ₂ O	IN H ₂ O	dB-A
PFB1212EHE	-R00 / -F00	12	8.0 to 13.2	1.60	19.20	4000	5.133	181.27	19.078	0.751	59.0
PFB1224EHE	-R00 / -F00	24	14.0 to 26.5	0.90	21.60						
PFB1248EHE	-R00 / -F00	48	30.0 to 56.0	0.45	21.60						
PFB1212GHE	-R00 / -F00	12	8.0 to 13.2	2.70	32.40	4800	6.167	217.80	27.308	1.075	64.0
PFB1224GHE	-R00 / -F00	24	14.0 to 26.5	1.35	32.40						
PFB1248GHE	-R00 / -F00	48	30.0 to 56.0	0.68	32.64						
PFB1212UHE	-R00 / -F00	12	8.0 to 13.2	4.00	48.00	5500	7.160	252.85	35.877	1.412	66.5
PFB1224UHE	-R00 / -F00	24	14.0 to 26.5	2.00	48.00						
PFB1248UHE	-R00 / -F00	48	30.0 to 56.0	1.00	48.00						

* Function type is optional.
 * The max. air flow and the speed are measured in free air ; max. air pressure is measured at zero air flow.
 * Noise is measured in anechoic chamber in free air, one meter from intake side.
 * All readings are typical values at rated voltage.
 * Specifications are subject to change without notice.